



INSTALLATION INSTRUCTIONS

Accessory
REAR BUMPER APPLIQUE
P/N 08P48-TS8-100

Application
2015 CIVIC
2-DOOR

Publications No.
VERSION 1

Issue Date
SEPT 2014

PARTS LIST

Rear bumper applique

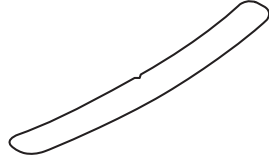

Applicator

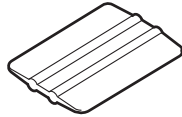

Soft sleeve

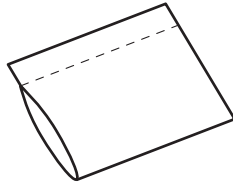

Alcohol swab

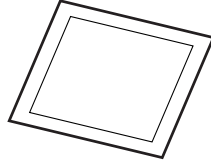

TOOLS AND SUPPLIES REQUIRED

Shop towel

Spray bottle

3M Protective tape application solution

Masking tape

Felt-tip pen

INSTALLATION

NOTE:

- Be careful not to damage the paint finish.
 - This rear bumper applique kit should be installed only if the ambient air temperature is 15°C (60°F) or above.
 - To allow the adhesive to cure, do not wash the vehicle for 24 hours. Please advise the customer.
1. Open the trunk lid. Using the alcohol swab, thoroughly clean the area where the rear bumper applique will attach.

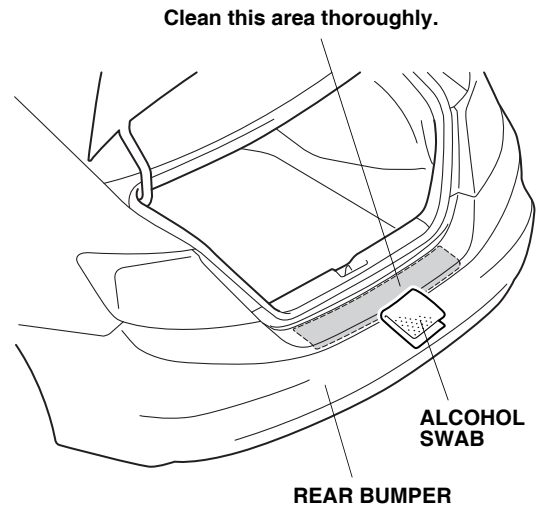

QB61701AJ

- Attach a strip of masking tape to the rear bumper in the area shown. Using a felt-tip pen, make a mark on the tape at the center of the trunk lid anchor.

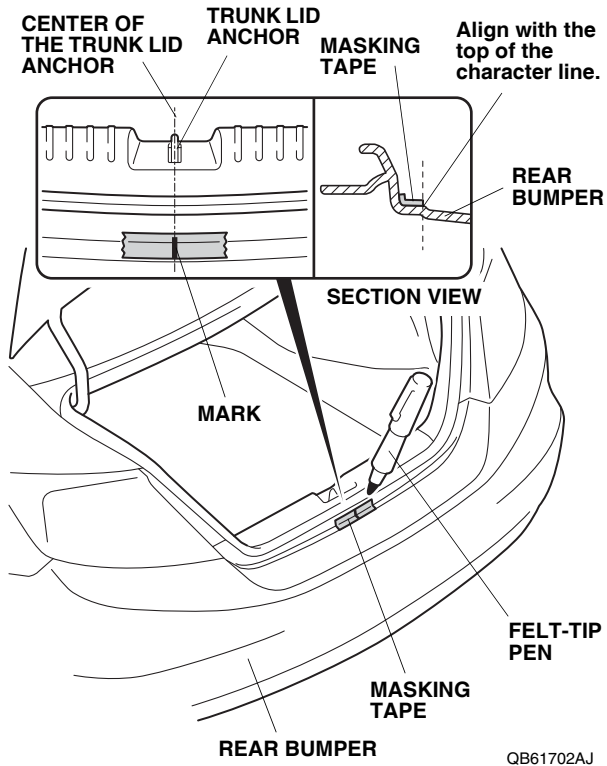

QB61702AJ

- Using a spray bottle with 3M protective tape application solution, spray the area where the rear bumper applique will attach. Spray some solution on your hands.

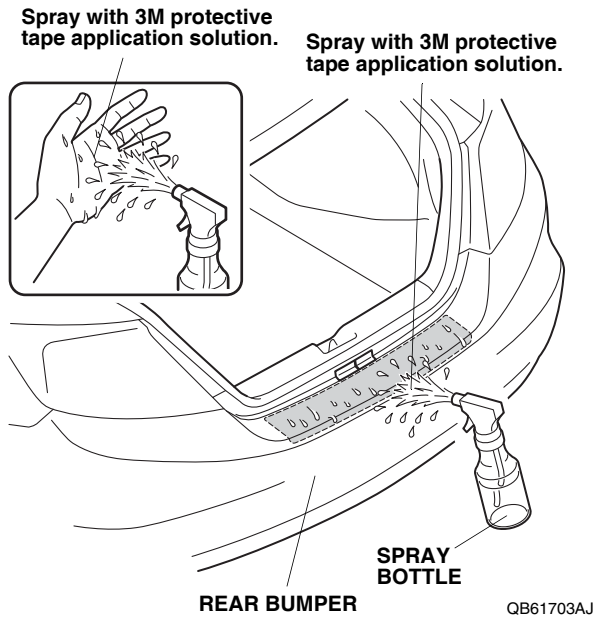

QB61703AJ

- Remove the adhesive backing (side with the 3M mark) from the rear bumper applique.

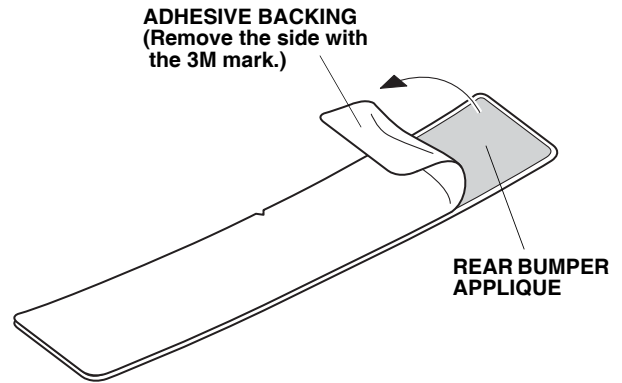

QB61704AJ

- Spray the rear bumper applique with 3M protective tape application solution.

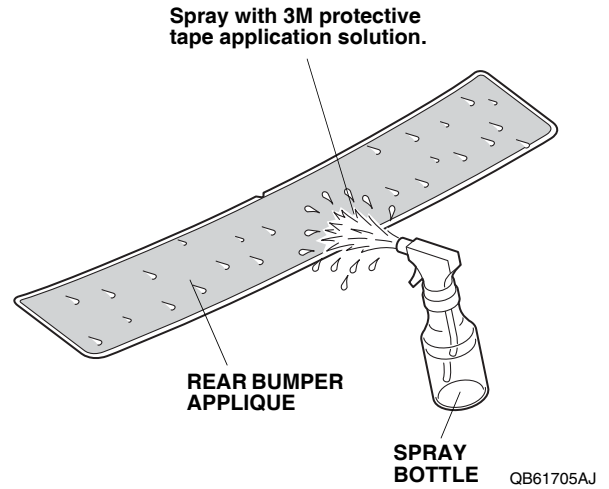

QB61705AJ

- Align the v-notch on the rear bumper applique with the mark on the masking tape. Align the edge of the rear bumper applique with the bottom of the character line. Smooth the rear bumper applique against the rear bumper and the bottom of the character line.

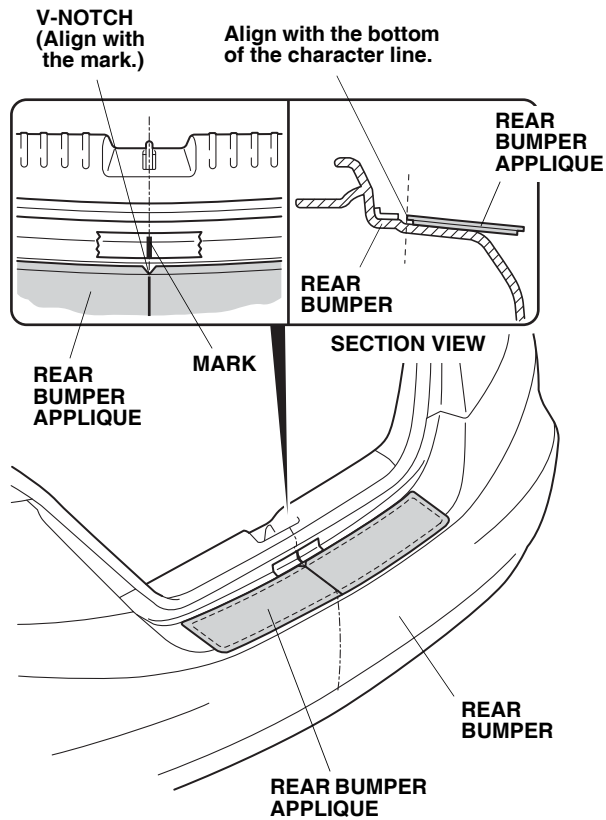

- Insert the applicator into the soft sleeve.

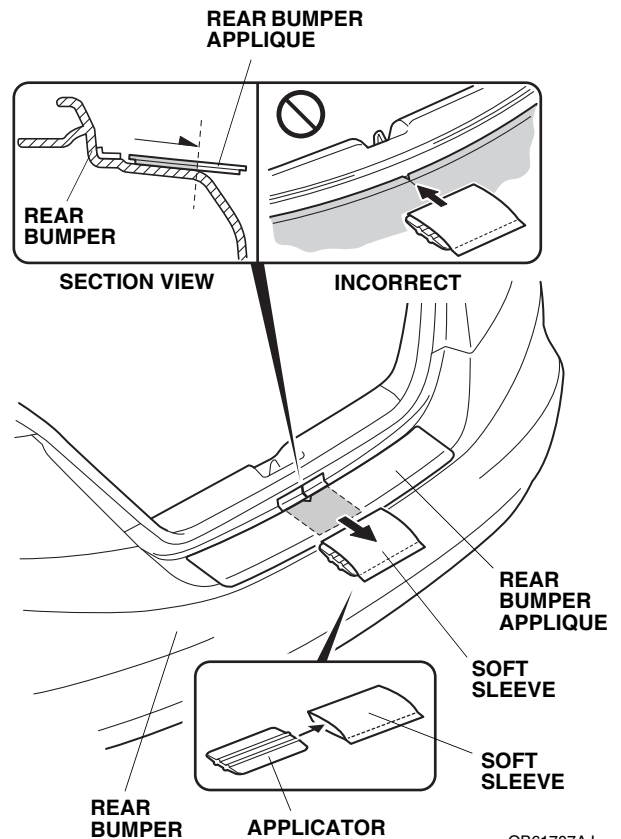

- Starting from the center and working outward, use the soft sleeve to smooth out the center of the upper section on the rear bumper applique. Move the soft sleeve in one direction only. If you see an air bubble, stop and gently peel up that section to work out the bubble.

- Starting from the center and working outward, use the soft sleeve to smooth the rear bumper applique on the left and right sides of the upper section of the rear bumper applique. Move the soft sleeve in one direction only. If you see an air bubble, stop and gently peel up that section to work out the bubble. Work slowly and keep pressure against the rear bumper applique.

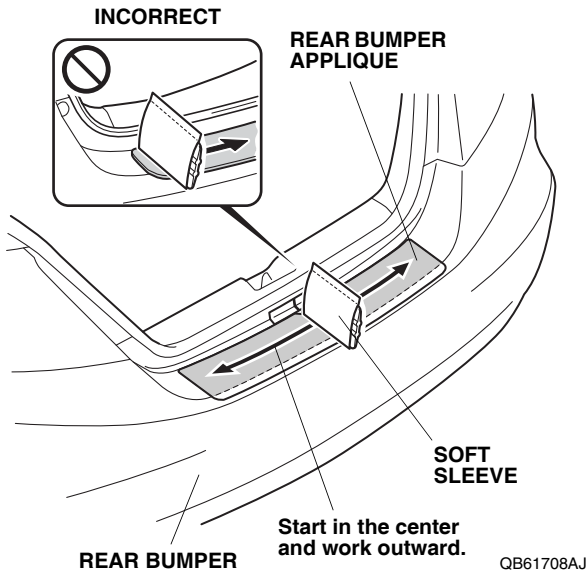

- Slowly remove the protective film from the top of the rear bumper applique. Remove the protective film by pulling it slowly and horizontally; do not pull it vertically.

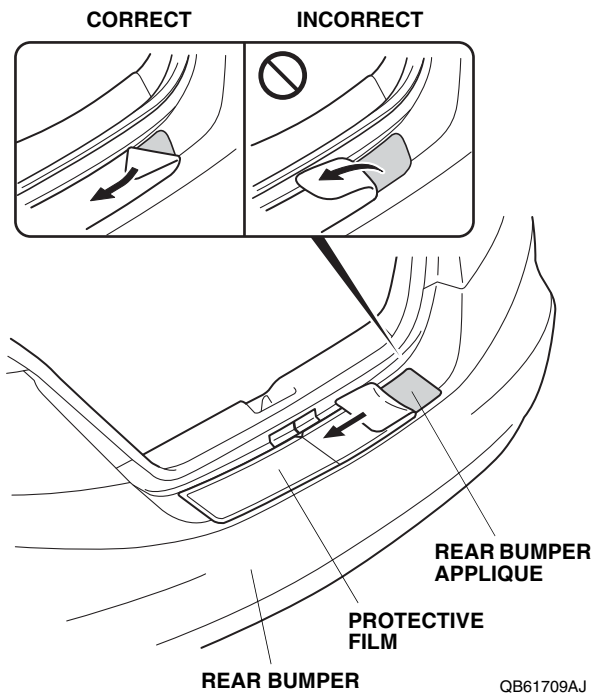

- Repeat step 8 for the center of the lower section of the rear bumper applique.

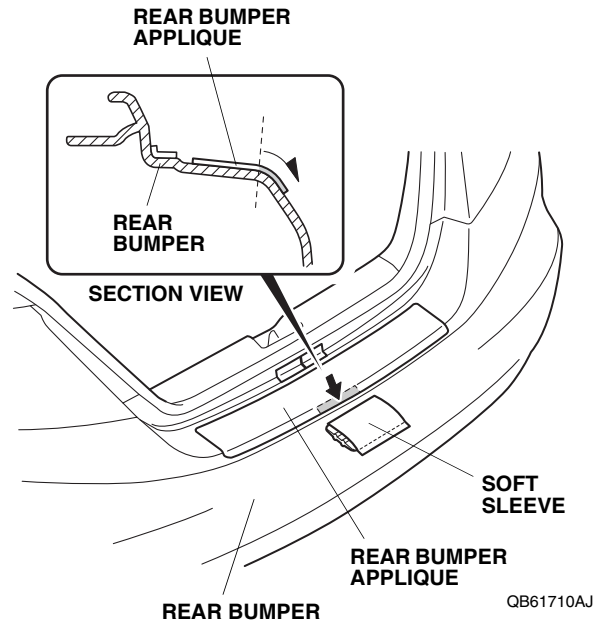

- Use the soft sleeve to adhere the rear bumper applique to the lower section as shown.

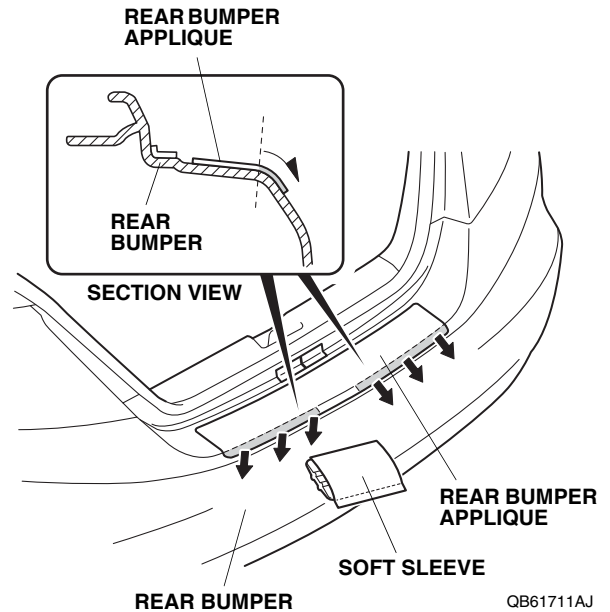

- Using a shop towel, wipe away the excess 3M protective tape application solution. Allow the rear bumper applique to dry thoroughly.

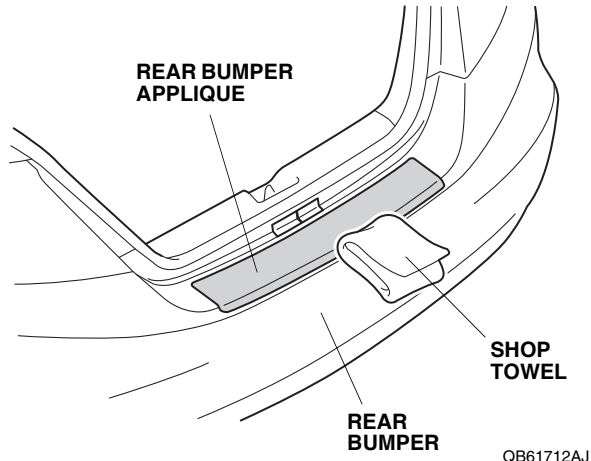

- Remove the masking tape attached in step 2.